

# Front side

# GLOBO

LIGHTING

## 48547SH

smart voice control 

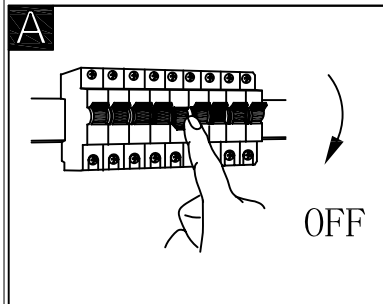



**B**

- 3 LIGHT STEPS 3000 K - 6500 K
- APP
- 3000 K - 6500 K
- dimmable
- incl.
- memory function
- many steps
- night light

smart APP control

free APP

compatible with Alexa  Powered By  

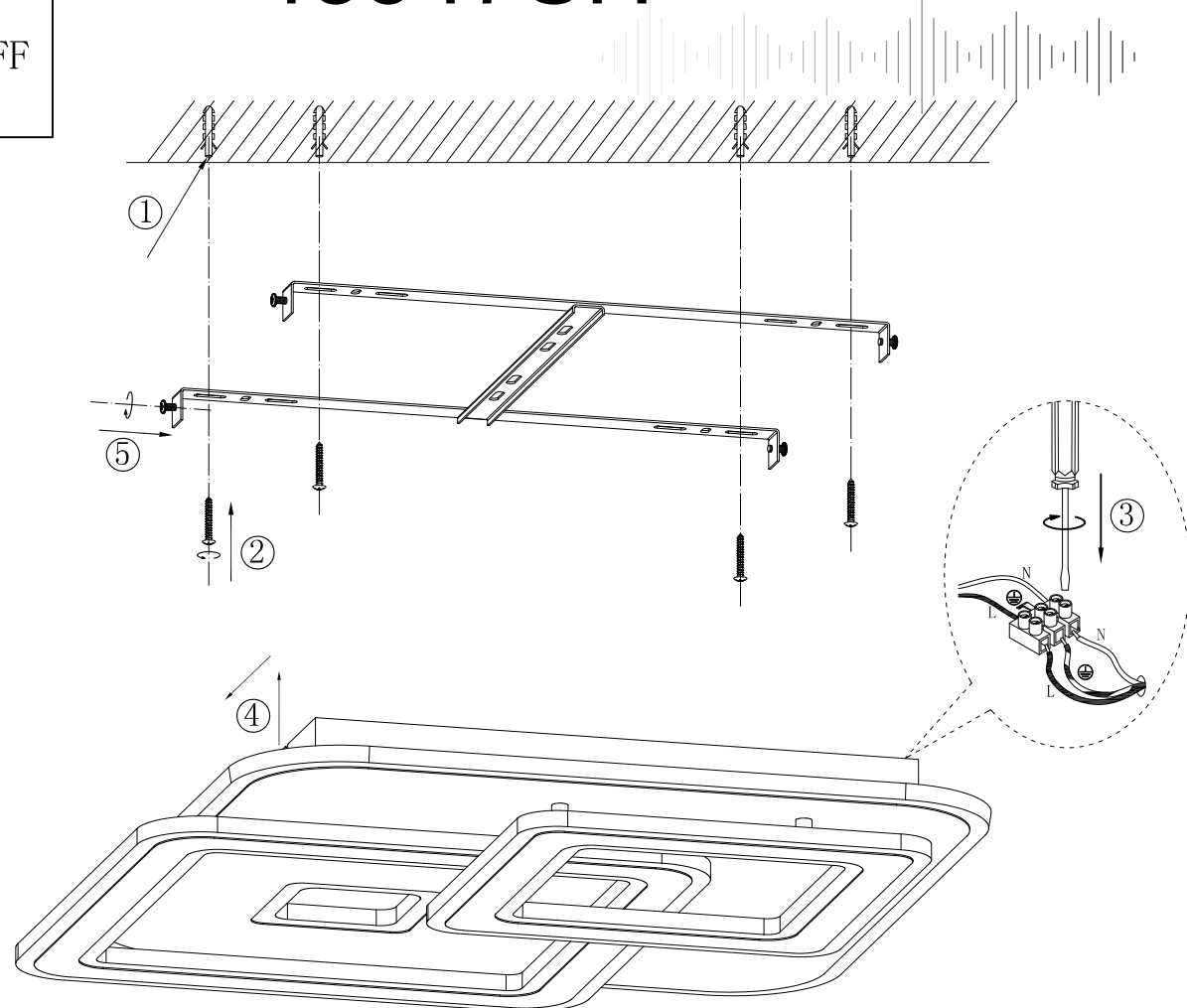

Frequency Bandwidth	Maximal radiation transmitting power
2445MHz	6dBm

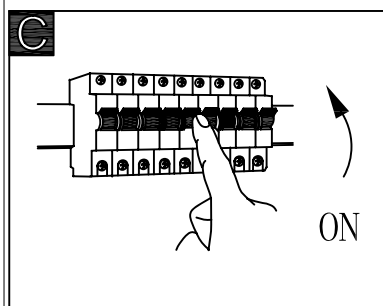
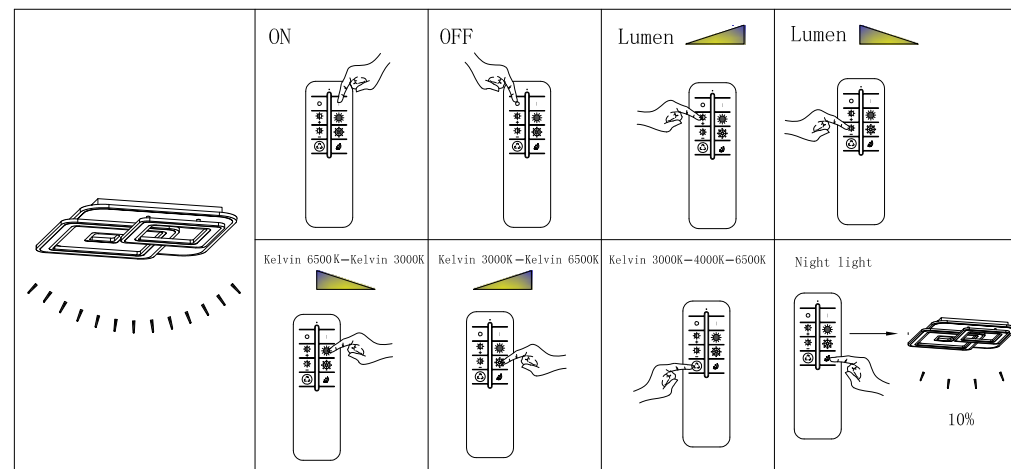

GLOBO Handels GmbH  
 Gewerbestrasse 3  
 A-9184 Sankt Peter, AUSTRIA  
[www.globo-lighting.com](http://www.globo-lighting.com)

# Back side

Download Tuya App:



Functional Video:



## Tuya App - Pairing Process

