

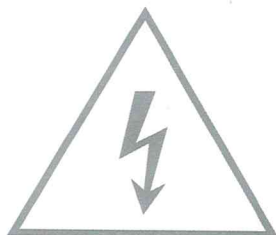

Fischer & Honsel GmbH  
Graf-Gottfried-Str. 111  
D-59755 Arnsberg  
+49 (0) 2932 – 989 – 0  
www.fischer-honsel.de  
info@fischer-honsel.de

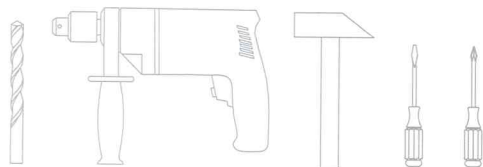

**Vorsicht, Gefahr des elektrischen Schlags**

Die Lichtquelle dieser Leuchte ist nicht ersetzbar; wenn die Lichtquelle ihr Lebensdauerende erreicht hat, ist die gesamte Leuchte zu ersetzen.

**Caution, risk of electric shock**

The light source of this luminaire is not replaceable; when the light source reaches its end of life the whole luminaire shall be replaced.

**Danger, risque de chocs électriques**

La source lumineuse de ce luminaire n'est pas remplaçable; lorsque la source lumineuse atteint sa fin de sa vie), le luminaire entier doit être remplacé.



FISCHER & HONSEL

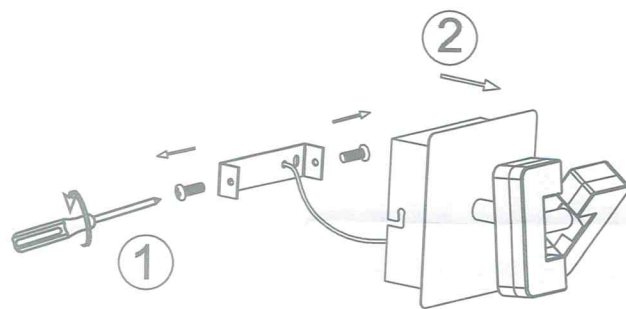
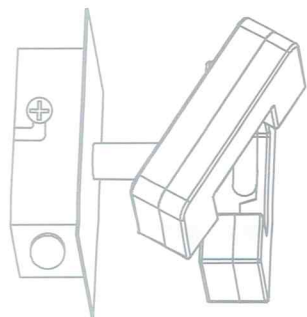

1

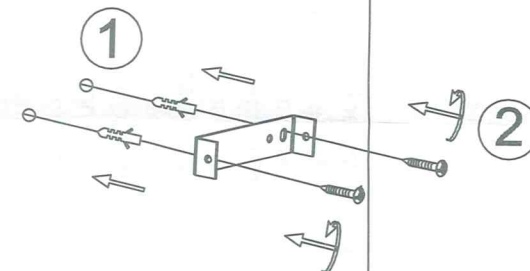

2

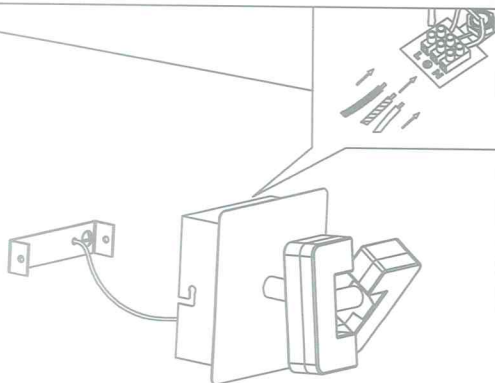

3

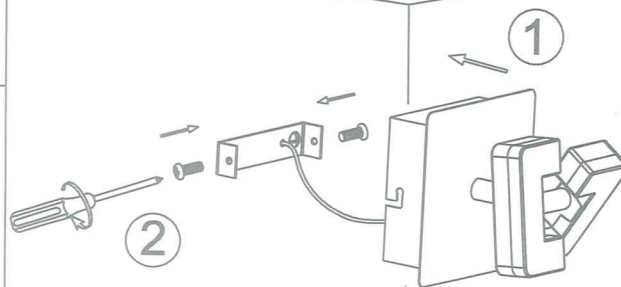

4

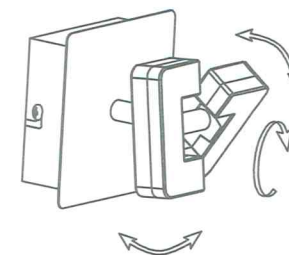

5